

INSTALLATION, SERVICE AND MAINTENANCE INSTRUCTIONS

ANNEX FOR CE ATEX MARKED EQUIPMENT ACCORDING TO DIRECTIVE
2014/34/EU:

COUNTER-ROTATING AGITATOR

MCR Ex



20.072.32.0001



Original Manual
20.072.30.03EN
(A) 2022/11

EU Declaration of Conformity

We:

INOXPA, S.A.U.
Telers, 60
17820 - Banyoles (Girona)

Hereby declare under Our sole responsibility that the machine

COUNTER-ROTATING AGITATOR

Model

MCR

Type

MCR-1, MCR-2, MCR-3, MCR-4, MCR-5, MCR-6, MCR-7, MCR-8

From serial number **IXXXXXXXXX** to **IXXXXXXXXX** ⁽¹⁾

is in compliance with all applicable provisions of the following directive:

Directive ATEX 2014/34/UE

Harmonized technicals norms applicable:

EN ISO 80079-36:2016
EN ISO 80079-37:2016
EN 1127-1:2019
EN 13237:2012
EN 15198:2007
EN IEC 60079-0:2018

This Declaration of Conformity covers equipment with the following ATEX marking:

 II 2G Ex h IIB T4...T3 Gb

 II 2D Ex h IIIB T125 °C...T200 °C Db

 II 2G Ex h IIB T4...T3 Gb
II 2D Ex h IIIB T125 °C...T200 °C Db

⁽¹⁾ where X is a numeric character

The technical documentation referenced 13719678-775657 is on file with the notified body LABORATOIRE CENTRAL DES INDUSTRIES ELECTRIQUES (LCIE), 33, Av. du Général Leclerc BP 8, 92266 Fontenay-aux-Roses, France. Reference num. 0081.

The person authorized to compile the technical documentation is the signer of this document.



Banyoles, 2022

David Reyro Brunet
Technical Office Manager

⁽¹⁾ where X is a numeric character

1. Table of Contents

1. Table of Contents	
2. Generalities	
2.1. Instructions manual	3
2.2. Compliance with the instructions	3
2.3. Warranty.....	3
3. Safety	
3.1. Warning symbols.....	4
3.2. General safety instructions	4
4. General Information	
4.1. Description	6
4.2. Principle of operation	6
4.3. Application.....	6
5. Installation	
5.1. Reception of the agitator	7
5.2. Identification of the agitator	8
5.3. Transport and storage.....	8
5.4. Location.....	8
5.5. Electrical installation	9
5.6. Assembly.....	10
6. Start-up	
7. Troubleshooting	
8. Maintenance	
8.1. General considerations	14
8.2. Maintenance.....	14
8.3. Lubrication.....	14
8.4. Spare parts.....	14
8.5. Conservation	15
8.6. Cleaning	15
8.7. Disassembly and assembly of the agitator	15
9. Technical Specifications	
9.1. Materials.....	17
9.2. Other features	17
9.3. Dimensions	17
9.4. Exploded drawing and parts list	17

2. Generalities

2.1. INSTRUCTIONS MANUAL

This manual contains information about the reception, installation, operation, assembly, disassembly and maintenance of counter-rotating agitator.

Carefully read the instruction prior to starting the agitator, familiarize yourself with the installation, operation and correct use of the agitator and strictly follow the instructions. These instructions should be kept in a safe location near the installation area.

The information published in the instruction manual is based on updated data.

INOXPA reserves the right to modify this instruction manual without prior notice.

2.2. COMPLIANCE WITH THE INSTRUCTIONS

Not following the instructions may impose a risk for the operators, the environment and the machine, and may result in the loss of the right to claim damages.

This non-compliance may result in the following risks:

- Failure of important machine/plant functions.
- Failure of specific maintenance and repair procedures.
- Possible electrical, mechanical and chemical hazards.
- Risk to the environment due to the type of substances released.

2.3. WARRANTY

Any warranty will be void immediately and lawfully and, additionally, INOXPA will be compensated for any civil liability claims submitted by third parties, in the following cases:

- The service and maintenance work have not been carried out in accordance with the service instructions, the repairs have not been carried out by our personnel or have been carried out without our written authorisation.
- Modifications have been carried out on our material or equipment without written authorisation.
- The parts or lubricants used are not original INOXPA parts and products.
- The material or equipment has been improperly used, has been used negligently, or has not been used according to the instructions and their intended.

The General Conditions of Delivery already in your possession are also applicable.



The machine may not undergo any modification without prior approval from the manufacturer. For your safety, only use original spare parts and accessories.

The usage of other parts will relieve the manufacturer of any liability.

Changing the service conditions can only be carried out with prior written authorization from INOXPA.

The agitator was selected for use in explosive atmospheres at the time of placing the order, according to ATEX form. INOXPA is not liable for any damage that may arise if the information provided by the buyer is incomplete or incorrect (liquid type, viscosity, RPM, classification of the potentially explosive area, gas generated by the potentially explosive atmosphere, etc).

Please do not hesitate to contact us in case of doubts or if further explanations are required regarding specific data (adjustments, assembly, disassembly, etc.).

3. Safety

3.1. WARNING SYMBOLS



Safety hazard for people in general and/or for equipment



Electric hazard



Danger of formation of explosive atmospheres or generation of ignition sources of potentially explosive atmospheres

ATTENTION

Important instruction to prevent damage to the equipment and its functions

3.2. GENERAL SAFETY INSTRUCTIONS



Read the instruction manual carefully before installing and starting the agitator. Contact INOXPA in case of doubt.

3.2.1. During the installation

The [Technical Specifications](#) of [chapter 9](#) should always be observed.

The installation and use of the agitator should always be in accordance with applicable regulations in regard to health and safety.



Before starting up the agitator, check that it is properly anchored and its shaft is perfectly aligned. Incorrect alignment and/or excessive stress during coupling can cause serious mechanical problems in the agitator.

Take all possible precautions when lifting the agitator. Always use properly attached slings when moving the agitator with a crane or other lifting device.

Keep the motor and the switchboard under control, particularly in areas where there is a risk of fire or explosion.



When cleaning, do not spray directly on the engine.

Do not disassemble the agitator until the switchboard has been disconnected. Remove the fuses and disconnect the power cable supplying the motor.

All electric work should be carried out by specialised personnel.

3.2.2. During operation



The [Technical Specifications](#) of [chapter 9](#) should always be observed. Under no circumstances can the specified limit values be exceeded.

Before starting up the agitator, remove all the tools used during the assembly.

Do not operate the agitator when the rotating parts are not equipped with their guards or are not properly assembled.

The agitator has rotating parts. Do not place hands or fingers in the agitator while it is operating. This may cause serious injuries.



Do not touch the parts of the agitator that are in contact with the fluid when in operation. When the agitator operates with hot fluids (temperatures above 50°C), there is a risk of skin burning. In such cases, collective-protection means (in this order or priority: separation, protective screen, heat-insulating material) or, in the absence of this, individual protection gear (gloves) must be used.



The agitator and its installation can generate sound levels above 85 dB(A) under unfavourable operating conditions. In such cases, the operators must use devices for protection against noise.

3.2.3. During maintenance



The [Technical Specifications](#) of [chapter 9](#) shall always be observed.

The agitator cannot operate without fluid. Standard agitators are not designed to work during the filling or emptying of tanks.

from INOXPA.

The maximum operating conditions of the agitator should not be exceeded. Nor should the operating parameters for which the agitator was initially designed be modified without written authorisations



Do not leave loose parts on the floor.

Do not disassemble the agitator until the switchboard has been disconnected. Remove the fuses and disconnect the power cable supplying the motor.

All the electric work should be carried out by specialised personnel.

4. General Information

4.1. DESCRIPTION

The counter-rotating agitator series comprises a range of vertical agitators with a central propeller and anchor with scrapers in counter-rotating configuration. They use a sealing system through dry mechanical seal or Garlock lip seals.

With the bottom tripod option, place a probe or any other control system to avoid working dry.

For the MCR series agitators, the drives must be suitable for operation in explosive atmospheres.

Mechanical seal suitable for working in classified areas. The installation instructions provided by the seal supplier must be followed.

Mechanical seal dry work. Follow the mechanical seal manufacturer's instructions at all times.

- **Double mechanical seal option. Must be protected by controlling the washing liquid, if applicable.**
 - Check the level of supply reserve.
 - Check the temperature of the washing liquid.
 - Check the pressure.
 - Check the condition of the washing liquid: Change the washing liquid if it has been contaminated by another liquid. Contamination of the liquid means that the pump is not functioning properly and it must be inspected. For example, the sealing system may have leaks in the middle or be open due to insufficient backpressure of the washing liquid.



The washing liquid must always be under pressure when the pump is operating.

The agitator was selected for use in explosive atmospheres at the time of placing the order, according to ATEX form. INOXPA is not liable for any damage that may arise if the information provided by the buyer is incomplete or incorrect (liquid type, viscosity, RPM, classification of the potentially explosive area, gas generated by the potentially explosive atmosphere, etc).

4.2. PRINCIPLE OF OPERATION

This agitator consists of a concentric propeller and anchor driven by two superimposed geared motors through a hollow shaft for the anchor which turns in one direction at a relatively slow speed and a solid shaft for the propeller which goes inside the hollow shaft and turns in the opposite direction and at higher speed.

4.3. APPLICATION

Counter-rotating agitators are used for mixing and homogenizing dispersed products at a controlled temperature with an optimum performance, regardless of the product viscosity. These units are intended primarily for pharmaceutical, cosmetics, food and chemical industries.

They are ideal for processes which require heating, vacuum, premixing, additions, vigorous agitation, emulsion or dispersion, as well as pressure and temperature. Some examples of products that can be treated with these units are all kinds of creams, gels, sunscreens, depilatories, makeup, deodorants, sauces, pates, shoe creams, emulsions, paraffin mixtures, wax mixtures, carbopol dispersions, tooth pastes, products intended for drugstores and parapharmacies.



Each agitator has performance limits. The agitator was selected for a given set of mixing conditions when the order was placed. INOXPA shall not be held responsible for any damage that might be suffered or malfunctioning of the equipment if the information provided by the buyer is incomplete or incorrect. (e.g. nature of the fluids or installation details).

5. Installation

5.1. RECEPTION OF THE AGITATOR



INOXPA is not liable for any deterioration of the material caused by its transport or unpacking. Visually check that the packaging has not been damaged.



If the agitator is supplied without a drive or other element, the purchaser shall be responsible for its assembly, installation, start-up and operation.

When receiving the agitator, check the packaging and its content to ensure that it matches the delivery note. INOXPA packs the agitators in their fully assembled form or disassembled on a case-by-case basis. Ensure that the agitator has not been damaged in any way. If it is not in good condition and/or any parts are missing, the carrier must submit a report as soon as possible.

The following documentation is included with the agitator:

- shipping documents,
- instructions and Servicing manual for the agitator,
- instructions and Servicing manual for the gear-motor when the agitator is supplied with a motor by INOXPA.

Check the ATEX CE marking on the nameplate of the machine and verify that it meets the conditions of the order.

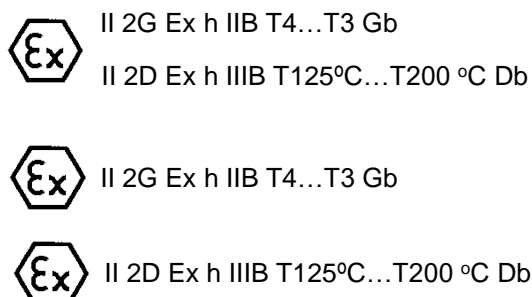

Figure 1.1.: ATEX CE marking on the nameplate.

Should the marking on the machine not correspond with the order, please contact INOXPA immediately to explain the situation.

The temperature class and the maximum surface temperature depend on the temperature of the product to be stirred and the ambient temperature.

Temperature class for explosive gas atmospheres

Temperature class	Product temperature (in process or cleaning)	Room temperature
T4	≤ 110 °C	-20 °C to +40 °C
T3	≤ 140 °C	-20 °C to +40 °C

Maximum surface temperature for explosive dust atmospheres

Maximum surface temperature	Product temperature (in process or cleaning)	Room temperature
T125 °C	≤ 125 °C	-20 °C to +40 °C
T200 °C	≤ 200 °C	-20 °C to +40 °C

5.2. IDENTIFICATION OF THE AGITATOR

The agitator is identified using a rating plate fixed onto the motor. The type of agitator and the serial number appear on the nameplate.

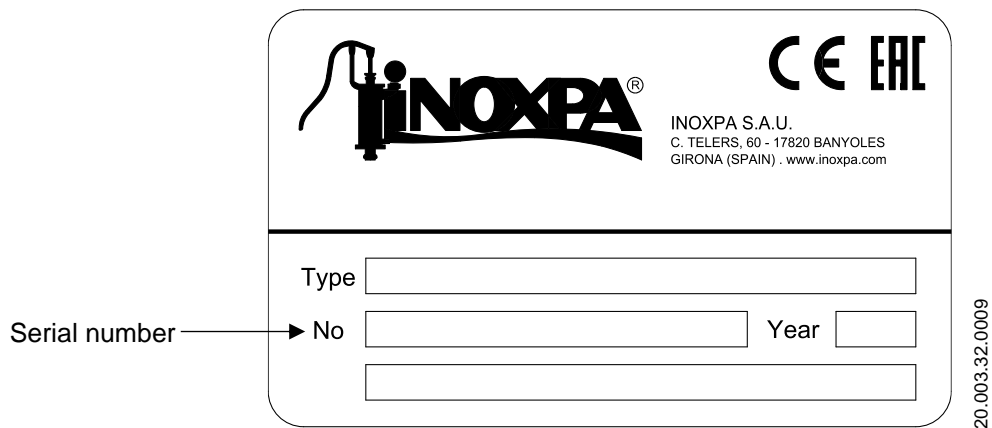

In addition to the information in the manual it should be taken into account that ATEX equipment will be provided with the corresponding marking.

5.3. TRANSPORT AND STORAGE

ATTENTION



According to the model, the agitators are too heavy to be stored or installed manually. Use an appropriate mode of transport. Do not handle the agitator by the shaft as this may become deformed.

ATTENTION



Take all possible precautions when lifting the agitator. Always use properly attached slings when moving the agitator with a crane or other lifting device.

If the agitator is not to be installed immediately, it must be stored in an appropriate place. The shaft must be stored in a horizontal position and placed on wooden supports or a similar material. In this position, the shaft will not become deformed but it must not be subject to any type of load.

5.4. LOCATION

Place the agitator in such a way as to facilitate inspections and checks. Leave enough room around the agitator for service, disassembly and maintenance operations. It is very important to be able to access the electric connection device of the agitator, even when in operation.

It is very important to be able to access the electrical wiring and connections on the agitator, even when it is in operation.

Please be aware that while handling any equipment with an electrical connection, a potentially explosive atmosphere may be present, and for this reason safe work permits should be issued.

Some type of air recirculation for cooling the gear motor on the agitator must be provided.

Make sure that there are no other systems or surfaces close to the gear motor which may radiate additional heat or may affect its cooling capacity. See instruction manual of the gear motor.

Install a separate fan, if necessary, taking into account the atmosphere in which the fan should be operating (potentially explosive atmosphere).

Excessive temperatures

Depending on the fluid being agitated, high temperatures can be reached within and around the agitator:

It should be taken into account that, under normal conditions, the surface temperature of the agitator is a function of the temperature of the fluid being agitated, therefore the table of temperature classes and maximum surface temperature in section 5.1 must be taken into account.

5.5. ELECTRICAL INSTALLATION

Before connecting the electrical motor to the mains, check local regulations on electrical safety as well as the applicable standards.

Check the instructions manual of the manufacturer of the motor for information on how to connect it to the mains.



Take the connection of the electrical motors must be performed by qualified personnel.

Take the appropriate measures to prevent any fault.

The motor must be provided with devices for protection against power overload and short-circuits.

The agitator cannot be used in areas where there is a risk of fire or explosion when this has not been specified in the order.

Before connecting the gear motor to the power supply, consult the supplier's instruction manual. The gear motor must be ATEX certified and with adequate protection for the work environment in which it is intended to operate.

Before connecting a gear motor to the mains, check the local electrical safety regulations, as well as the specifications of standards EN 60204-1 and EN 60079-14 currents of the moment.

Electrical equipment, terminals and components of the control systems may still bear electrical current when they are disconnected. Making physical contact with them can endanger the safety of the operators and the installation or cause irreparable damage to the equipment; the supplier's instructions for the safe opening of the gear motor must be carefully followed at all times.

Safe work permits shall be issued if the system is to be handled in the presence of potentially explosive atmospheres; it is recommended to do this kind of work in non-classified atmospheres (no explosive atmosphere can be present at the location of the agitator during its handling).

Follow the gear motor manufacturer's instructions at all times.

The switchgear must comply with all applicable regulations, as stipulated in the electrical safety regulations as well as the directions laid down by the manufacturer of the ATEX gear motor.

In addition, overload protections suitable for the gear motor power rating must be installed on the gear motor.

5.6. ASSEMBLY

To locate and fix the agitator in the support flange of the tank, the propeller must be removed from the shaft. Once the base of the agitator is placed on the supporting flange, the fixing nuts and screws will be assembled in their corresponding holes, without being tightened. When this operation has been carried out, the agitator must be levelled using the following method:

1. Place a spirit level against the shaft.
2. Check 4 points at 90° to each other around the circumference of the shaft and at the same height.
3. Once the shaft is level, firmly tighten the fixing nuts and screws. Finally, the propeller is mounted on the end of the shaft. Be careful when assembling the shaft not to hit or strain it so as to avoid it being bent.

**ATTENTION**

Force should never be applied to the end of the agitator shaft, as it can easily suffer permanent damage.

**ATTENTION**

Check the alignment of the agitator shaft with the half shaft once its assembly is completed.

ATEX agitators are very compact machines and are always supplied together with the drive.

A pressurization tank for double mechanical seal, it must be ensured that the tank is always at a height of between 1 and 2 meters with respect to the inlet and outlet of the mechanical seal. See instructions manual for the mechanical seal and pressurization canister. Verify that the instrumentation in the pressurization tank is suitable for the work area. Prevent the cooling circuit from running out of liquid.

6. Start-up



The start-up of the agitator can be carried out provided the instructions indicated in the chapter 5. [Installation](#) have been followed.

- Check that the power supply matches the rating indicated on the motor plate.
- Check the alignment of the agitator shaft.
- Check the level of fluid in the tank. When not specified in the order, the agitator cannot be operated during the filling or emptying of the tank.
- All the guards must be in place.
- Start up the agitator.
- Check that the direction of rotation of the propellers is correct (it must rotate clockwise when seen from the drive side). See the next figure:

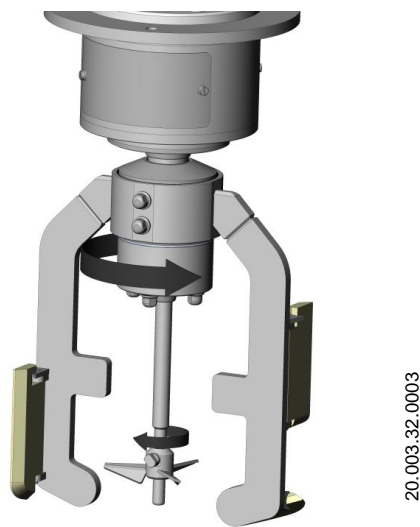

Follow the direction of rotation of the agitation components as indicated by the arrow attached to the engine. An incorrect direction of rotations results in a loss of agitation performance.

- Check the electrical power draw of the motor.

ATTENTION

Do not modify the operating parameters for which the agitator was initially designed without written authorisation from INOXPA (risk of damage and user hazard).



Follow the instructions for use and the safety requirements described in the instructions manual for the tank in which the agitator is mounted.

Mechanical risks (e.g. drag, shear, cutting, impact, flattening and pinching). If the agitation element is accessible from the top or the tank inspections hatch, then the user will be exposed to the above-mentioned risks.

The tank must be fitted with protective devices and safety equipment. Consult the manufacturer's instructions manual.

ATTENTION



Introducing an object or solid raw material may cause the agitation component and other mechanical parts to break and compromise its safety or guarantee.

Explosive atmospheres may be generated during the start-up of the agitator, and safe work permits should be issued for this purpose. These tasks shall only be carried out by qualified or trained personnel.

Do not modify the operating parameters initially set for the agitator, according to ATEX Form sheet; since this could result in deterioration and the risk of formation of explosive atmospheres and ignition sources, placing the operator in danger.

The agitator cannot operate with no fluid in the tank. Therefore, a safety system is required to ensure a minimum fluid level of 350 mm above the top blade when the agitator is running.

7. Troubleshooting

8. Maintenance

8.1. GENERAL CONSIDERATIONS

This agitator, just like any other machine, requires maintenance. The instructions contained in this manual cover the identification and replacement of spare parts. The instructions are aimed at maintenance personnel and those responsible for the supply of spare parts.

Maintenance of any equipment intended for use in potentially explosive atmospheres shall only be carried out in conjunction with the use of safe work permits as specified in Directive 1999/92/EC.

Carefully read chapter [9. Technical Specifications](#).



Maintenance work can only be carried out by qualified personnel that are trained and equipped with the necessary resources to carrying out this work.

Before beginning maintenance work, ensure that the electric motor is disconnected and that the tank is empty.

All parts or materials that are replaced must be properly disposed of/recycled in accordance with the current directives applicable in each area.



Before beginning maintenance work, ensure that the agitator is disconnected.

8.2. MAINTENANCE

- Inspect the agitator regularly.
- Do not fail to keep the agitator clean.
- Check the state of the motor or the gear motor.
- Check the state of the bearings.
- Check the sealing: seal and/or V-ring.

Motor or gear motor maintenance shall be carried out in accordance with the manufacturer's instructions, see the instructions manual.

The possible presence or generation of explosive atmospheres should be taken into account during maintenance work, and safe work permits should therefore be used accordingly.

Maintenance of the gear motor shall be performed according to the manufacturer's specifications; refer to the manufacturer's instruction manual.

Use tools which are technically suitable for the specific maintenance and repair work involved. If the area is not declassified, all the tools used must be non-sparking and safe work permits shall be required.

In the case of painting the parts of the agitator (except drive), the type of paint to be used must be conductive, dissipative or antistatic insulating, so that no accumulation of charges occurs or, if yes, these are controlled (paint must have a surface resistivity $\leq 1 \text{ Gohm}$).

8.3. LUBRICATION

Follow the manufacturer's indications when lubricating the geared motor's bearings.

8.4. SPARE PARTS

To order spare parts it is necessary to indicate the type and serial number included on the agitator's characteristics plate, as well as the position and description of the part as found in chapter [9. Technical Specifications](#).

To request spare parts for an agitator intended to work in a classified zone, it is necessary to explicitly indicate in the order that it is an ATEX agitator and include the manufacturing number.

If the spare parts are not requested in this way, Inoxpa shall not be responsible for the case that the agitator may not operate with parts which are not suitable for the classified zone where is installed.

8.5. CONSERVATION

If the agitator is out of service for a considerable period of time, clean and treat the parts with VG46 mineral oil. The shaft must be stored in the horizontal position and on wooden supports or on supports of a similar material.

8.6. CLEANING



The use of aggressive cleaning products such as caustic soda and nitric acid may give raise to skin burns.

Use rubber gloves during cleaning procedures.

Always use protective goggles.

8.6.1. Automatic CIP (clean-in-place)

8.6.2. Automatic SIP (sterilization-in-place)

8.7. DISASSEMBLY AND ASSEMBLY OF THE AGITATOR

Disassembly or assembly of any equipment intended for use in potentially explosive atmospheres shall only be carried out in conjunction with the use of safe work permits as specified in the Directive 1999/92/EC.

Both the assembly and disassembly of agitators must be performed by qualified personnel, using only appropriate tools, as well as suitable working methods.

Use tools which are technically suitable for the specific maintenance and repair work involved. If the area is not declassified, all tools must be non-sparking and safe work permits must be issued.

Incorrect assembly or disassembly may cause the agitator to malfunction and lead to high repair costs and a long down-time period, even invalidating the system's protection systems.

INOXPA is not responsible for accidents or damages caused by failure to comply with the instruction manual and with this annex.

Cleaning

Before disassembling the agitator, it must be cleaned both on the outside and on the inside. Furthermore, the possible presence or formation of explosive atmospheres should be taken into account, and safe work permits should therefore be used accordingly.



The disassembly and assembly of the agitators should only be carried out by qualified personnel using only appropriate tools. Ensure that staff read these instructions manual attentively, particularly the instructions that relate to their work.



Stop the motor from starting up when carrying out assembly and disassembly work on the agitator.

Place the agitator switch in the "off" position.

Lock out the electrical switchboard or place a warning sign.

Remove the fuses and take them to the workplace.

8.7.1. Disassembly of the agitator

8.7.2. Assembly of the agitator

9. Technical Specifications

9.1. MATERIALS

Parts in contact with the product	AISI 316L
Other steel parts	AISI 304L
Elastomers	EPDM / FPM
Scrapers	PTFE
Sealing system	SiC/SiC/EPDM EDV mechanical seal / PTFE Gylon lip seal
Surface finish	Ra ≤ 0,8 µm (0.4 µm available special order)
Working pressure	-1 ... 6 bar
Working temperature	-10 ... 120 °C

Temperature range. See section 5.1.

9.2. OTHER FEATURES

9.3. DIMENSIONS

9.4. EXPLODED DRAWING AND PARTS LIST

NOTES

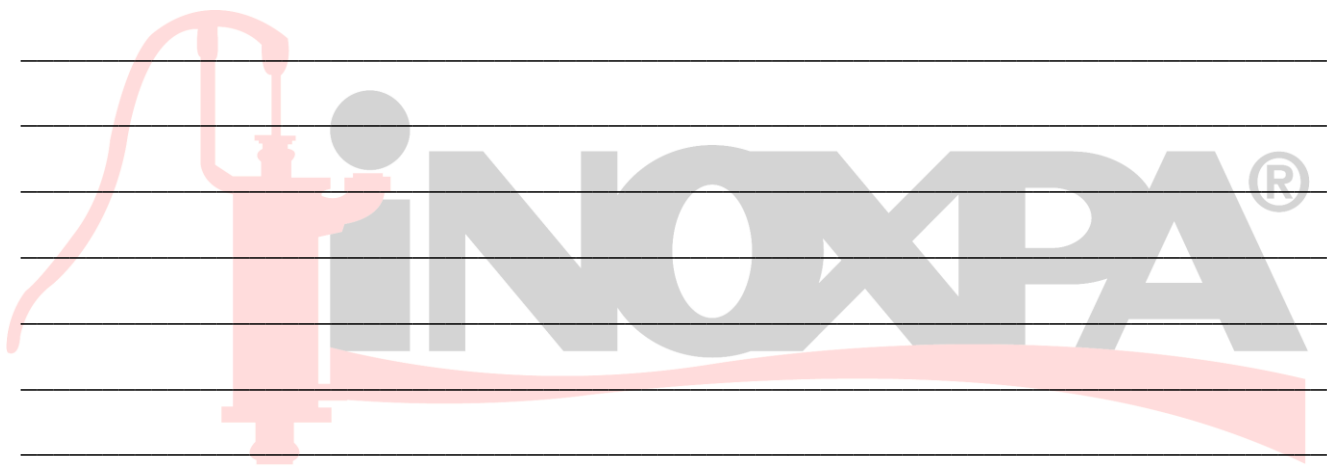

NOTES



How to contact INOXPA S.A.U.:

Contact details for all countries are continually updated on our website.

Please visit www.inoxpa.com to access the information.

